

MC4558 / **CD4558**

Dual Operational Amplifier

Features

- No frequency compensation required.
- No latch up.
- Large common mode and differential voltage range.
- Parameter tracking over temperature range.
- Gain and phase match between amplifiers.
- Internally frequency compensated.
- Low noise input transistors.

Descriptions

The MC4558 series is a monolithic integrated circuit designed for dual operational amplifier.

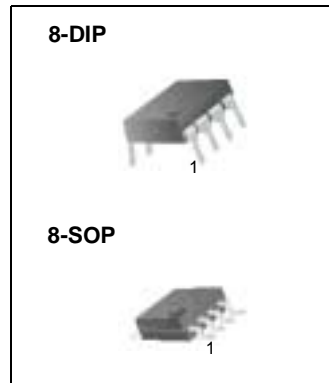

Internal Block Diagram

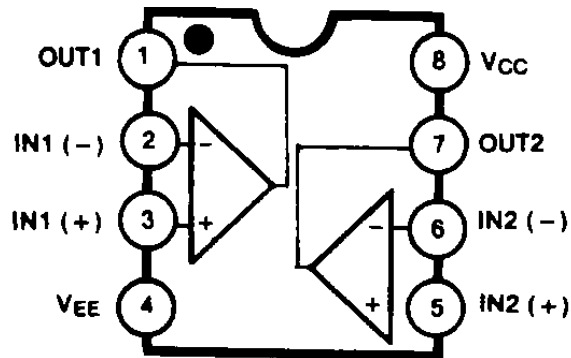

Schematic Diagram

(One Section Only)

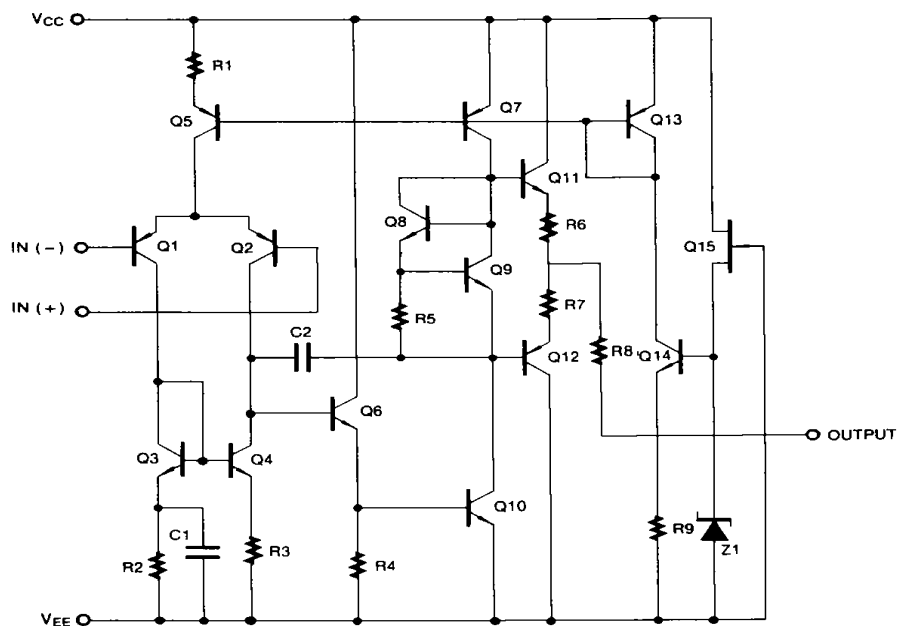

Absolute Maximum Ratings

Parameter	Symbol	Value	Unit
Supply Voltage	VCC	±22	V
Differential Input Voltage	VI(DIFF)	30	V
Input Voltage	VI	±15	V
Power Dissipation	PD	400	mW
Operating Temperature Range	TOPR	0 ~ 70 -40 ~ 85	°C
Storage Temperature Range	TSTG	-65 ~ 150	°C

Electrical Characteristics

(VCC = 15V, VEE = - 15V ,TA = 25 °C unless otherwise specified)

Parameter	Symbol	Conditions	MC4558C/MC4558V			Unit	
			Min	Typ	Max		
Input Offset Voltage	V _{IO}	R _S ≤ 10KΩ Note 1	-	2	6	mV	
			-	-	7.5		
Input Offset Current	I _{IO}		-	5	200	nA	
			T _A = T _A (MAX)	-	-		300
			T _A = T _A (MIN)	-	-		300
Input Bias Current	I _{BIAS}		-	30	500	nA	
			T _A = T _A (MAX)	-	-		800
			T _A = T _A (MIN)	-	-		800
Large Signal Voltage Gain	G _V	V _O (P-P) = ±10V, R _L ≤ 2KΩ Note 1	20	200	-	V/mV	
			-	-	-		
Common Mode Input Voltage Range	V _I (R)		±12	±13	-	V	
			-	-	-		
Common Mode Rejection Ratio	CMRR	R _S ≤ 10KΩ Note 1	70	90	-	dB	
			-	-	-		
Supply Voltage Rejection Ratio	PSRR	R _S ≤ 10KΩ Note 1	76	90	-	dB	
			76	90	-		
Output Voltage Swing	V _O (P.P)	R _L ≥ 10KΩ	±12	±14	-	V	
		R _L ≥ 2KΩ	±10	±13	-		
Supply Current (Both Amplifiers)	I _{CC}		-	3.5	5.8	mA	
			T _A = T _A (MAX)	-	-		5.0
			T _A = T _A (MIN)	-	-		6.7
Power Consumption (Both Amplifiers)	P _C		-	70	170	mW	
			T _A = T _A (MAX)	-	-		150
			T _A = T _A (MIN)	-	-		200
Slew Rate (Note2)	SR	V _I = 10V, R _L ≥ 2KΩ C _I ≤ 100pF	1.2	-	-	V/μs	
Rise Time (Note2)	T _R	V _I = 20mV, R _L ≥ 2KΩ C _I ≤ 100pF	-	0.3	-	μs	
Overshoot (Note2)	OS	V _I = 20mV, R _L ≥ 2KΩ C _I ≤ 100pF	-	15	-	%	

Note :

- MC4558C : T_A(MIN) ≤ T_A ≤ T_A(MAX) = 0 ≤ T_A ≤ 70 °C , MC4558V : T_A(MIN) ≤ T_A ≤ T_A(MAX) = -40 ≤ T_A ≤ +85 °C
- Guaranteed by design.

Typical Performance Characteristics

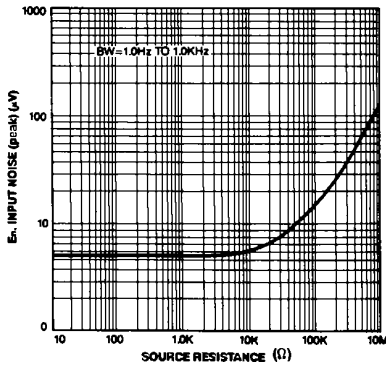

Figure 1. Burst Noise vs Source Resistance

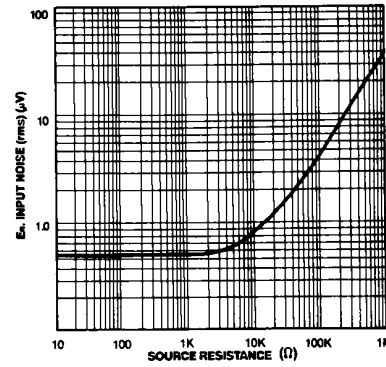

Figure 2. RMS Noise vs Source Resistance

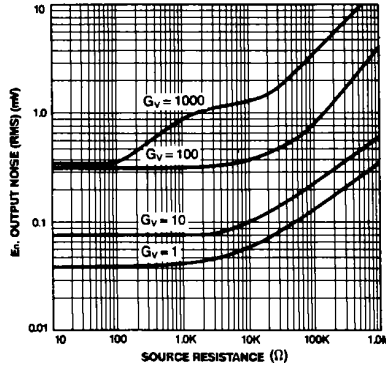

Figure 3. Output Noise vs Source Resistance

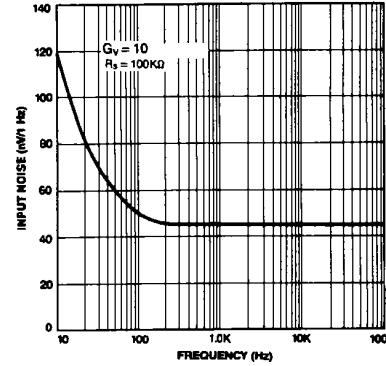

Figure 4. Spectral Noise Density

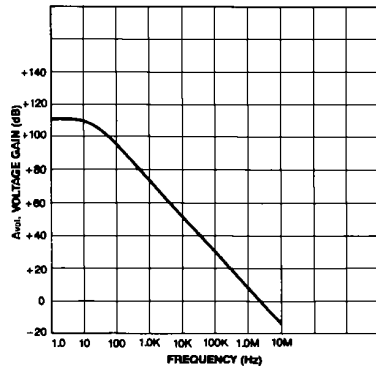

Figure 5. Open Loop Frequency Response

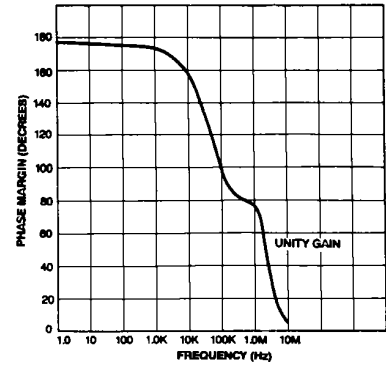

Figure 6. Phase Margin vs Frequency

Typical Performance Characteristics (continued)

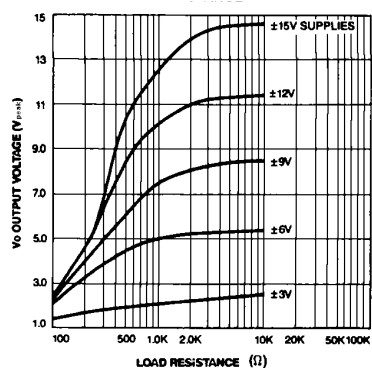

Figure 7. Positive Output Voltage Swing vs Load Resistance

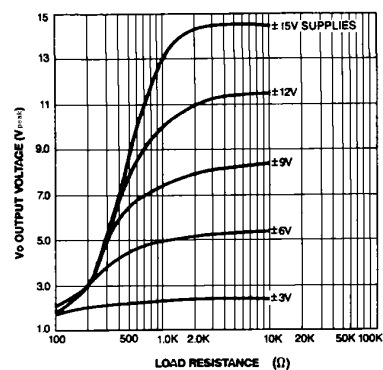

Figure 8. Negative Output Voltage Swing vs Load Resistance

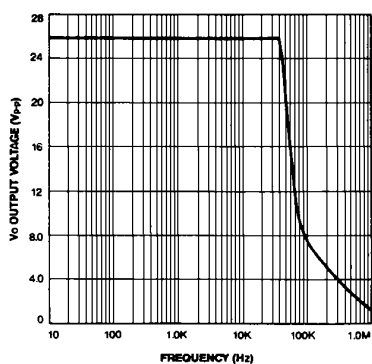

Figure 9. Power Bandwidth
(Large Signal Output Swing vs Frequency)

Mechanical Dimensions

Package

8-DIP

